



# Konfiguration JuCon ES2-Plug 1/2

Stückzahl

Buchsentyp 

Steckertyp 

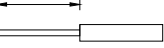
mm Abisolierlänge 

gerader Schnitt

Buchsentyp 

Steckertyp 

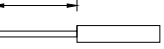
mm Abisolierlänge 

gerader Schnitt

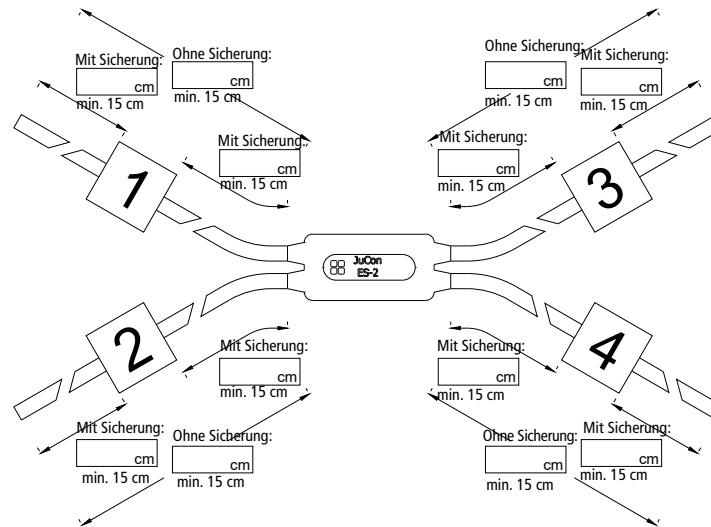

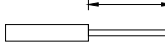

Buchsentyp 

Steckertyp 

Abisolierlänge   mm

gerader Schnitt

Buchsentyp 

Steckertyp 

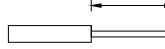
Abisolierlänge   mm

gerader Schnitt

Pos.# (1,2,3 oder 4):

1 2 3 4

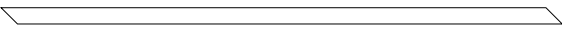
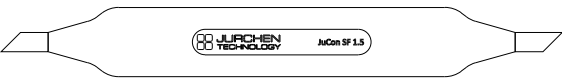
<input type="text"/>		Nur PV-Leitung	<input type="checkbox"/>	<input type="checkbox"/>	<input type="checkbox"/>	<input type="checkbox"/>
<input type="text"/> A / <input type="text"/> 1500 V		Stringsicherung JuCon SF 1.5	<input type="checkbox"/>	<input type="checkbox"/>	<input type="checkbox"/>	<input type="checkbox"/>

**Konfigurationsbeispiel:**

ES2 ohne Sicherung an #1, #2, #4 und einer 1500V-Sicherung an #3:

<input checked="" type="checkbox"/>	<input checked="" type="checkbox"/>	<input type="checkbox"/>	<input checked="" type="checkbox"/>
<input type="checkbox"/>	<input type="checkbox"/>	<input checked="" type="checkbox"/>	<input type="checkbox"/>

## Konfiguration JuCon ES2-Plug 2/2

Bemerkungen:

Kunde: \_\_\_\_\_  
Termin: \_\_\_\_\_  
Projekt: \_\_\_\_\_  
Besonderheiten: \_\_\_\_\_

Lieferung: FCA Werk / Selbstabholung durch Kunde  
CIF via Seefracht \_\_\_\_\_  
DAP \_\_\_\_\_



Lieferadresse (für CIF or DAP)

Empfänger (Vor- & Nachname):

Straße + Hausnr.:

Postleitzahl + Ort / Hafen:

Land:

Projektleiter

(oder Anfragsteller) :